

Solutions Around the Core

Analog, Interfaces, and NFC



Table of Contents

Overview	page 3
Networking	
CAN, LIN, Ethernet	page 4
System Power	
Load Switches	page 5
AC/DC	page 5
PMICs, Safety & Networking SBCs	page 6
Power Drivers	
Smart Power Switches, Motor & Gate Drivers, SoC Controllers, LED Drivers	page 7
Energy Management	
USB Type-C Applications	page 8
Battery Chargers & Battery Management	page 9
Signal Management	
Signal MUX and Switches	page 10
Voltage Level Translators	page 11
Real-Time Clocks	page 12
GPIO Expanders	page 12
HMIs	
LED Controllers	page 13
LCD Drivers	page 13
Interfaces	
I ² C MUX and Switches	page 14
NFC - A different kind of wireless	
Access Control (Physical and Logical)	page 15
Pairing & Commissioning	page 15
Accessories & Consumables	page 16
Parameterization, Diagnosis and FW update	page 16
Device-to-Device and In-Device Communication	page 17
Payment	page 17

Solutions Around the Core Overview

At NXP, our broad portfolio of analog, interface and NFC solutions means that we are able to offer complete solutions around the core. With a range of options that attach to any core, our product expertise in areas such as NFC, power management, networking and interfaces is deep-rooted. We are recognized as an industry leader and innovator, and we are active in defining industry standards groups for the automotive and industrial markets.

Here's more about our solutions for your next automotive or industrial design:

- We have a substantial market share in I²C bus devices with a vast portfolio that includes LED controllers, voltage translators, RTCs, GPIO expanders, LCD drivers, temperature sensors, I²C MUX and switches, and buffers.
- A robust range of audio devices are available for customer-specific designs or complete turnkey solutions.
- Our portfolio for in-vehicle networking covers CAN, LIN, FlexRay transceivers and controllers as well as flexible power management through the system-basis chip (SBC) offering.
- USB Type-C helps ready your design for the future; our complete end-to-end solutions offer rich interface capabilities with "Alternate Mode" support and includes high-speed signal switches, USB redrivers/signal conditions, PD-PHY and CC-Logic controllers and authentication.
- Highly integrated AC-to-DC, DC-to-DC, battery management and power management ICs can help simplify your power tree.
- NFC enables secure interactions with a simple touch and offers autonomous sensing, data processing and logging functionality with energy-harvesting power options.

Solutions Around the Core

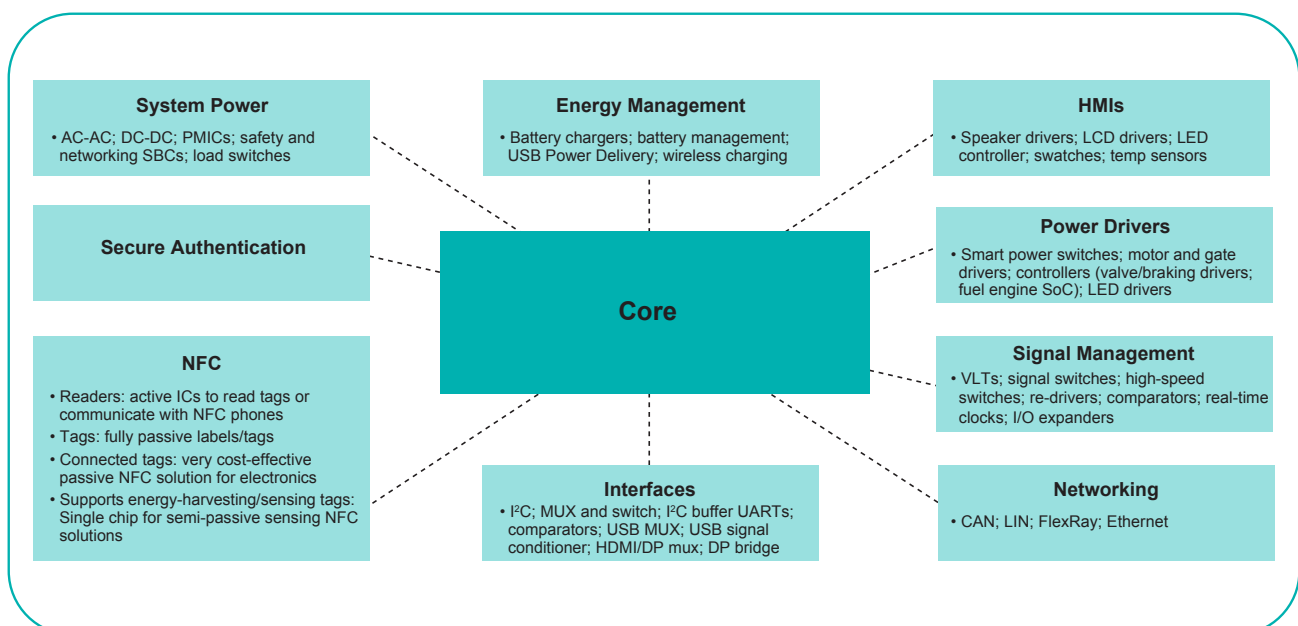

Solutions Around the Core Networking

CAN, LIN, Ethernet

CAN, LIN or Ethernet networking solutions may meet your design needs if:

- ▶ Your system runs on a 12 V or a 24 V battery system
- ▶ You need classical CAN, standby CAN, partial networking, or CAN flexible data rate (CAN FD)
- ▶ You're looking for automotive Ethernet communications running at 100 Mbit/s

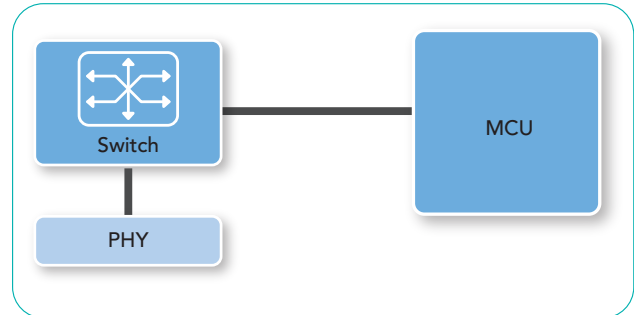

Device	Description	Automotive	Industrial
TJA1057GT TJA1044GT	12 V family of basic/standby CAN FD transceivers with optional 3.3 V V_{IO} pin, offering best-in-class EMC performance and common mode choke (useless up to 500 kbit/s); available in SO8 and HVSON8 packages	X	X
TJA1046TK	12 V dual standby CAN FD transceivers with optional 3.3 V V_{IO} pin, offering best-in-class EMC performance and available in leadless HVSON14 package	X	
TJA1051T/ TJA1042T	12 V/24 V family of basic/standby CAN FD transceivers with optional 3.3 V V_{IO} pin, supporting CAN FD data rates up to 5 Mbit/s and available in SO8 and HVSON8 packages	X	X
TJA1059TK	12 V/24 V dual standby HS CAN transceivers including 3.3 V V_{IO} pin and available in leadless HVSON14 package	X	
TJA1043T	12 V/24 V sleep mode CAN FD transceivers including 3.3 V V_{IO} pin; supporting CAN FD data rates up to 5 Mbit/s and available in SO14 and HVSON14 packages	X	
TJA1145AT	HS-CAN transceiver supporting CAN FD data rates up to 5 Mbit/s, including partial networking sleep mode and available in SO14 and HVSON14 packages	X	
TJA1052IT	HS-CAN transceiver supporting CAN FD data rates up to 5 Mbit/s with integrated galvanic isolation for high-voltage applications	X	
TJF1052IT	HS-CAN transceiver supporting data rates up to 5 Mbit/s with integrated galvanic isolation for high-voltage applications		X
TJA1021T/27T/29T TJA1022T/24HG	Single and multi LIN 2.x/SAE J2602 compliant LIN transceivers available in several package options	X	X
SJA1124 TJA1124	SPI-to-Quad LIN 2.x/SAE J2602 transceiver with integrated LIN controller and master termination, sleep mode and wake-up features	X	
TJA1101 TJA1102/S	Single/dual low-power 100BASE-T1 Ethernet PHY over unshielded twisted pair cable and designed to support ASIL A system requirements	X	X
SJA1105/P/Q/ R/S/T	5-port 10/100/1000 Mbit/s data rates Ethernet switch with AVB and TSN support as well as SGMII interface, RGMII internal delay line and double VLAN tagging support	X	X
MC33664	2 Mbit/s isolated network high-speed transceiver with dual SPI architecture to conveniently interface a microcontroller up to 15-node system with battery cell controller devices MC33771/ MC33772	X	
MC33CD1020 MC33CD1030	36 V analog switch interface multiplexer: translates up to 33 I/Os onto a single MCU SPI bus with very low quiescent current, configurable wetting currents (from 2 mA to 20 mA), integrated temperature and supply sensors	X	X

Solutions Around the Core

System Power

Load Switches

Your design may benefit from a load switch if:

- ▶ You're currently using MOSFETs for power distribution
- ▶ Your application is battery powered or power sensitive
- ▶ You want the ability to turn off portions of your system when they're not being used
- ▶ You need overvoltage, overcurrent, overtemperature or other protection features

One integrated load switch can replace four discrete components.

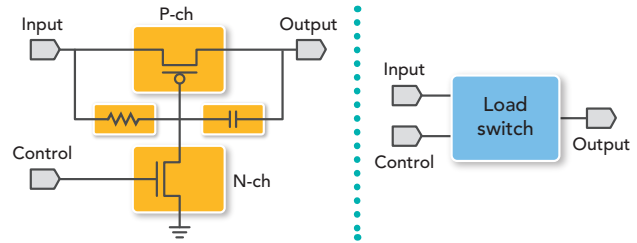

Function	Profile	Hero Parts	Key Applications	Value Proposition
Power sequencing and slew rate control	0.9 V – 3.6 V, 0.5 A	NX3P2902B	Wearable and portable applications	10 x lower quiescent current than competitors devices
	0.9 V – 5.5 V, 2.5 A	NX5P2924	Mobile and USB OTG	Low and flat on resistance
Surge protection	2.5 V – 20 V, 5 A	NX20P5090	USB Type-C applications	100 W USB Type-C load switch
	3.0 V – 5.75 V, 3 A	NX5P3001	Mobile and USB OTG	With integrated low capacitance TVS for D+ and D- lines
Charging path (with reverse current protection)	3 V – 5.5 V, 2 A	NX5P2190	USB Type-C applications	Smaller package size than competitor; 90 V surge protection (comp has no surge protection)
	2.5 V – 5.5 V, 3 A	NX5P3290 NX5P3363		
Source/Sink Combo Switch	2.8 V to 20 V; 5 A max sink current and 3.4A max source current	NX20P3483	Computing/USB Type-C applications	Supports fast role swap and dead battery operation
Bi-directional OVP Load Switch with I ² C Interface	2.8V to 20V; 6A max in OVP mode (sink) and 1.5A max in USB OTG mode (source)	NX30P6093A	High-current (quick) charging	I ² C control and programmable for OVP threshold, timing control, pin resistance current source value, and interrupt flag

AC/DC

AC-DC solutions help enable:

- ▶ Very high efficiency at low loads
- ▶ A very small form factor
- ▶ Easy design supported by live parameter programming via a GUI

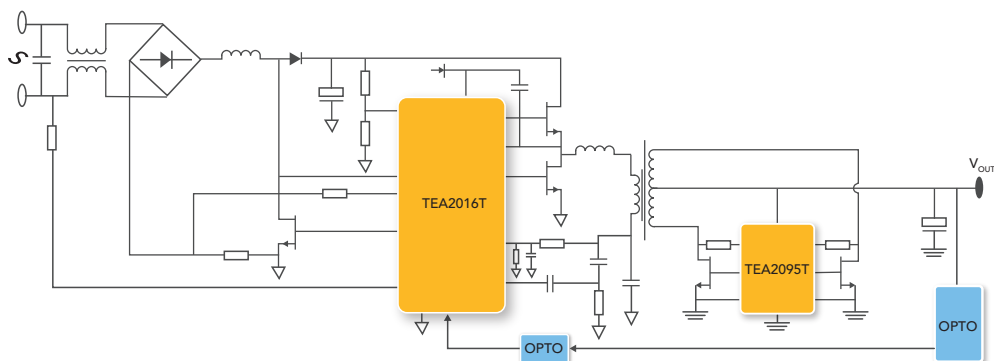

Function	Profile	Hero Parts	Key Applications	Value Proposition
Primary side PFC + LLC controller	SUPIC supply voltage up to 36V	TEA2016AAT	PC Power, AiO, Laptop adapters & gaming power supplies	Single SO16 package PFC + LLC combo controller. Extremely high efficiency from low load to medium load. Integrated X-cap discharge function via HV pin. Parameter programming during evaluation with use of a GUI.
Synchronous rectification control	Large supply voltage range operating from 4.5V up to 38V	TEA2095T	PC Power, AiO, Laptop adapters & gaming power supplies	Lower driver regulation level to support lower R _{ds(on)} mosfets (higher power levels) Shoot through protection to avoid conduction of both MOSFETS simultaneously Supports 500kHz switching frequency

Solutions Around the Core

System Power

PMICs, Safety and Networking SBCs

Your application may benefit from PMICs, Safety and Networking SBCs if:

- ▶ Your application connects to the car battery
- ▶ You need a PMIC to provide multiple and programmable regulated power rails for your system board
- ▶ Power consumption is important for your system board
- ▶ You need system power protection as overvoltage, overcurrent and thermal alert interrupts
- ▶ Your application is scalable with processor power levels

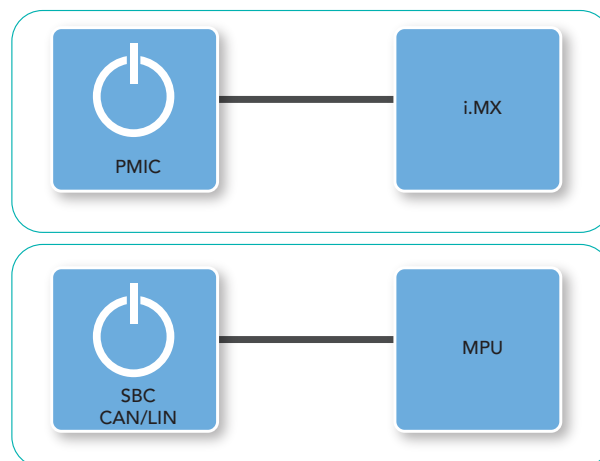

Device	Description	Automotive	Industrial
TJA1028T	LIN mini SBC in an SO8 or HVSON8 package with a LIN 2.x/SAE J2602 compliant LIN transceiver and a 5 V or 3.3 V LDO with 70 mA output current capability	X	
TJA1128	LIN mini SBC in an HVSON14 package integrating a LIN 2.x/SAE J2602 compliant LIN transceiver, with one time configuration via temporary SPI feature, 1 high voltage output, 1 wake input, and a 5 V or 3.3 V LDO with 85 mA output current capability as well as optional watchdog and 2nd wake input	X	
UJA116xA	Mini SBC product family with 5 V/100 mA LDO with integrated HS-CAN with support for CAN FD up to 5 Mbit/s, housed in very small HVSON package; integrated SPI interface and watchdog; versions available with partial networking and CAN FD passive support	X	
UJA107xA MC33903/4/5	Mid-range SBC product family including versions with 1 HS-CAN or 1 HS-CAN and 1/2 LIN; integrated 3.3 V/5 V LDO up to 400 mA with external PNP for thermal distribution; integrated SPI interface and watchdog function and local wake inputs	X	
UJA113x	High-power SMPS-based SBC product family with buck-only or buck-boost versions, housed in QFP48 package; output voltage 3.3 V/5 V up to 500 mA and integrated V_{AUX} sensor supply; integrated HS-CAN with CAN FD 2 Mbit/s support and up to 4 LIN; versions available with partial networking and CAN FD passive support	X	
MC33FS45xx MC33FS65xx MC35FS45xx MC35FS65xx	36 V system basis chip with energy-efficient DC-DC power conversion up to 2.2 A (2.0 A on V_{pre}) and low-voltage operation with configurable advanced fail silent behavior, long duration timer, keep-alive memory supply and optional integrated CAN FD transceiver; compliant with AEC-Q100 Grade 0 automotive qualification ($T_J=175^{\circ}C$)	X	
MMPF0100 MMPF0200	Quick-turn programmable 14-channel, 11.7 A (13-channel and 7.5 A for MMPF0200) system power management solutions with fully configurable voltages, sequencing and timings optimized for use with i.MX 6 series applications processors	X	X (+ consumer)
MC33PF3000 MC33PF3001	Optimized quick-turn programmable 12-channel, 7.3 A system power management solutions with fully configurable voltages, sequencing and timings optimized for use with i.MX 7 and i.MX 6 series applications processors available in a 7 x 7 mm package	X	X (+ consumer)
MC34VR500 MC34VR5100	9-channel power management IC, optimized to work with Layerscape® network processor systems (LS1021A, LS2024A, LS1043A, LS1046/47A, LS1012A) with custom pre-programmed output voltages, sequencing, and timings and available in a 7 x 7 mm QFN package		X
MC34PF1510 MC34PF1550	Ultra-low-power programmable 6-channel, 4 A system power management solutions with LED driver, JEITA temperature control and 1 A linear battery charger for i.MX 7ULP, i.MX 6UL/ULL applications processors in a 5x5 mm QFN-EP package		X (+ consumer)
MC34PF4210	Quick-turn programmable 12-channel, 12.7 A system power management solutions optimized for use with i.MX 8MQ and i.MX 8MD applications processors available in a 8 x 8 QFN wettable flank package		X (+ consumer)
MC33VR5500/ MC33FS84/85	System basis chips scalable in power and safety (from QM up to ASIL D) targeting 12 and 24 V applications such as infotainment (V2X) and ADAS (Vision, Radar) with power up/down configurable, static voltage scaling with SPI or I ² C communication		
MC33PF8100/1/21 MC33PF8200/1	Scalable, safe, programmable 11-channel, 19.1; A power management solutions optimized for use with i.MX 8 and i.MX 8X series applications processors available in a 8 x 8 mm QFN-EP package		
PCA9420	Power management IC for low-power microcontroller applications	X	X (+ consumer)
PCA9450	Power management IC for i.MX 8M Mini/Nano/Plus	X	X (+ consumer)

Solutions Around the Core

Power Drivers

Smart Power Switches, Motor & Gate Drivers, SoC Controllers, LED Drivers

- ▶ What type of loads does your system drive?
- ▶ What is the maximum input voltage for your application?
- ▶ How much maximum output current is needed?

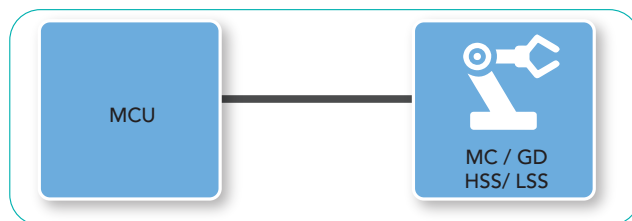

Category	Device	Description	Automotive	Industrial
LED Drivers	ASL15/25/45/4501SHN	Scalable series of 1, 2 and 4 phase boost converters with integrated SPI, diagnostic, up to 2 flexible and independent output voltages (<80 V) with 3% accuracy, external FETs and adjustable DC/DC converter frequency (125-700 kHz)	X	
	ASL2416SHN ASL3416SHN ASL2417SHN ASL3417SHN	2 and 3 multi-channel buck converters with integrated SPI, diagnostic, programmable LED current per channel up to 1.5 A with 5% accuracy, LED output voltage range up to 70V, external FETs and PWM dimming from 0 to 100%	X	
	ASL5008/5015	Matrix LED controller for up to 12 single LEDs or 4 segments of 3 switches, 0.8 A or 1.5 A per switch capability, 12 bit resolution, on-chip storage of preprogrammed PWM curves, single LED open/short detection, CAN interface option allowing to connect up to 32 Matrix LEDs Controllers together		
	Valve Drivers	MC33SB0400 MC33SB0401	One-wheel, two-wheel motorcycle ABS integrated device allowing heatsink removal	X
MC34SB0800 MC34SB0410		Fully integrated octal, quad valves and pump controller system on chip solutions with SPI, PWM up to 5 kHz (5.0 A), real-time valve current regulation (2.25 A – 2% precision w/ calibration) and integrated safe MOSFET for switching off all valves at once in case of emergency		X
Power Drivers	MPC17510/29 MPC17531 MPC17C724 MC34933	Low operating voltage (2 V to 15 V) monolithic single and dual H-Bridge for portable applications designed with low quiescent, integrated protection and diagnostics, 1 A output drive and PWM control input frequency up to 200 kHz capabilities		X
	MC33931 MC33932	Medium operating voltage (5 V to 36 V) monolithic single and dual 5A H-Bridge power ICs designed for harsh environments with selectable slew rate control, PWM up to 20 kHz, integrated protection and diagnostics in a thermally enhanced package	X	
	MC34931SEK MC34932SEK	Medium operating voltage (5 V to 36 V) monolithic single and dual 5A H-Bridge power ICs designed for harsh environments with selectable slew rate control, PWM up to 20 kHz, integrated protection and diagnostics in a thermally enhanced package		X
	MC33HB2000 MC33HB2001	3.0 A H-Bridge motor driver (5 V to 28 V) with SPI control for increased flexibility (current limits and slew rates configurable), low RDS(on) outputs (235 mΩ or 120 mΩ), PWM up to 35 kHz, daisy chainable, real-time current mirror and available in HQFN32 thermally enhanced package, HSOP32 leaded package and HVQFN28 thermally enhanced package	X	
Gate Drivers	MC33937 MC33GD3000	3-phase high current FET pre-driver (>1 A) with extended voltage range (6 V to 58 V), PWM (> 20kHz), robust fault-monitoring and failure protection for industrial brushless DC motor control (BLDC)	X	X
	MC33883	H-Bridge gate driver with charge pump, independent high and low side gate driver channels, PWM up to 100 kHz and up to 1.0 A peak gate driver current	X	
	MC33GD3100	Advanced gate driver (<10 A) for high-voltage power IGBTs with integrated high-voltage isolator, SPI interface, safety functions compliant with ASIL D applications and current sense feedback		
Small Engine Controllers	MC33812 MC33813/4	Small engine electronic fuel injection controller with diagnostics in order to meet air pollution emissions and fuel consumption for environmental legislation Euro 3 and Euro 4 for up to 2-cylinder and Euro 5 & OBDII for 1-cylinder (2 O2 heater pre-driver)	X	
Smart High Side Switches	MC33981	High current and high frequency 30 A/27 V, 60 kHz, 4 mΩ high-side switch with protected half bridge configuration enabling up to a 25% board area reduction and module simplification	X	X
	MC33982/4/8	Self-protected multipurpose single 2 mΩ, dual 4 mΩ or 8 mΩ low RDS(on) SPI-driven high side switches for flexible load management from 7 A to 30 A	X	X
	MC24XS4	Scalable, programmable family of 24 A/36 V SPI-driven, dual-channel, smart high-side switches from 6-to-50 mΩ RDS(on) for up to a 30% board reduction, and optimum for dense high-current switching applications	X	X
	MC12XS6	Scalable family of 22 A/18 V programmable penta, quad and triple high-side switches from 7-to-40 mΩ RDS(on) with wide-range diagnostic current sensing for up to 30% smaller PCB and 50% lower component count	X	X
Smart Low Side Switches	MC33XS2410	Quad 100 mΩ or dual 50 mΩ high side driver, 4 x 1.4 A DC current, operating from 3V to 60V, SPI-driven, fully programmable with wide-range diagnostic (short circuit current limit, over load protection, open load detection...), PWM signal and programmable dither signal for proportional solenoid valve	X	
	MC33882	Smart 6-output low-side switches able to control loads up to 1.0 A, daisy chainable SPI and parallel inputs control with PWM capability on all outputs	X	
	MC33880 MC33879	Configurable 8-output serial switches for load control up to 2.0 A with SPI, up to 2 direct control outputs for PWM applications and very low standby current, including monitoring and protection features	X	
	MC33996 MC33999	16-output low-side switches able to control loads up to 2.5 A, daisy chainable SPI with or without parallel inputs mode for PWM capability on all outputs	X	

Solutions Around the Core

Energy Management

USB Type-C

Take a deeper look into our USB Type-C solutions if:

- ▶ Your system has a USB connector and you're considering a move to USB Type-C
- ▶ You're planning to implement <15 W or > 15 W power through the Type-C connector
- ▶ Your system supports USB 2.0, USB 3.0, or USB 3.1 data
- ▶ You need a wide output voltage range supporting multiple charge protocols supporting the new USB-Type-C standard
- ▶ Your design supports video

USB Type-C

Seamless connectivity of data, video, and power over one reversible cable

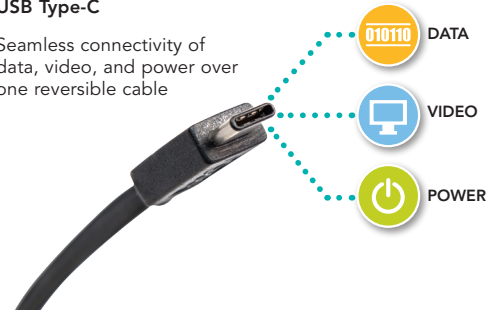

System Requirements	Hero Parts	Key Applications	Value Proposition
≤ 15 W, USB 2.0 Simple Type-C	Load switch: NX5P3290, NX5P3363 CC Logic: PTN5150A	<ul style="list-style-type: none"> ▶ Handheld POS ▶ Home health care ▶ Type-C accessories 	<ul style="list-style-type: none"> ▶ Simple to integrate in system ▶ No complex firmware engineering
≤ 15 W, USB 3.0 Simple Type-C	Load switch: NX5P3290, NX5P3363 USB 3.1 active sw: PTN36043 2:1 Mux: CBTU02043 CC logic: PTN5150A	<ul style="list-style-type: none"> ▶ Type-C LTE modem card ▶ High resolution camera ▶ Personal storage ▶ Internet gateway 	<ul style="list-style-type: none"> ▶ Simple to integrate in system ▶ No complex firmware engineering ▶ Smallest, high performance 2:1 mux in market
> 15 W Applications	PD PHY: PTN5110 Data switches: CBTL08GP053, CBTU02043 Load switches: NX20P5090, NX5P3290, NX5P3363 Authentication: A1006	<ul style="list-style-type: none"> ▶ Tablets ▶ Notebooks ▶ Portable/External hard drives ▶ Cable adaptors ▶ Dongles and accessories ▶ Desktop PCs 	System designers can use the USB Type-C Shield board with PTN5110 PD PHY and Kinetis® KL family or LPC54 family to quicken development time (part number OM13588)

HOST BOARD

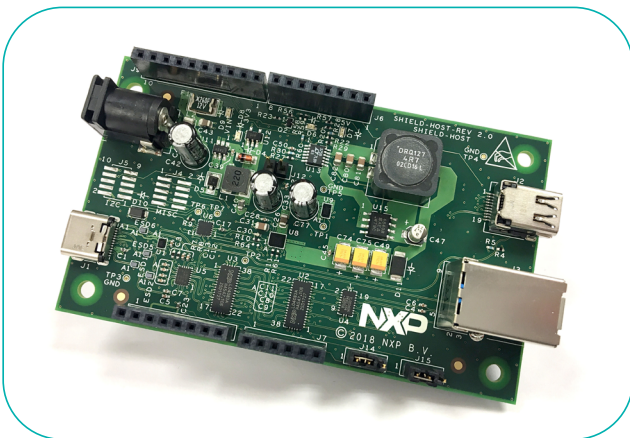

DOCK BOARD

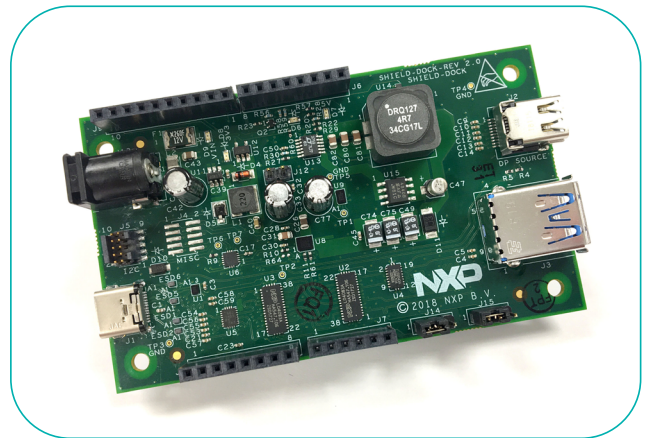

Solutions Around the Core

Energy Management

Battery Chargers & Battery Management

- ▶ Does your system have a Lead Acid battery back-up?
- ▶ What is the system battery voltage?

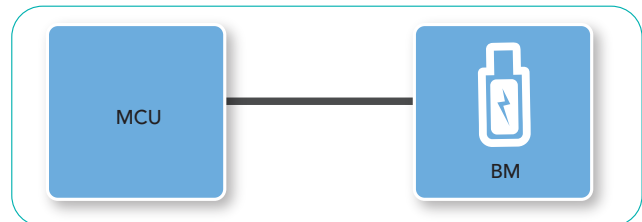

Device	Description	Automotive	Industrial
MC33771 MC33772	3 to 14-cell Li-ion Battery Cell Controller compatible for 5 V up to 1000 V packs with 2 Mbit/s transformer coupled daisy chain transceivers, 300 mA passive cell balancing and shunt current sensor	X	
MM912_637 MM9Z1_638	16-bit integrated MCU with 3 x 16-bit ADC for precision lead acid and Li-ion battery monitoring solutions with low system power consumption for mission-critical applications up to 52 V and higher voltage battery pack monitoring	X	
MC34671/3 MC34674	Scalable high-input voltage linear chargers for single cell Li-ion and Li-polymer batteries up to 1.2 A charge current with constant voltage accuracy down to 0.4% and constant current accuracy down to 5% available into a small 8-lead 2 mm x 3 mm x 0.65 mm UDFN thermally enhanced package		X

Solutions Around the Core

Signal Management

Signal MUX and Switches

Your design may benefit from our signal MUX and switches if:

- ▶ You need signal switches to simplify control/data signal routing and help ease design and layout
- ▶ You need multiple inputs and outputs
- ▶ You have demanding bandwidth requirements

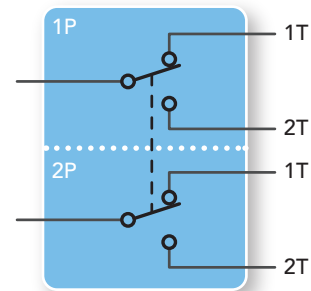

Hero Parts	Key Applications	Value Proposition	Other Emerging Markets
High-speed switches CBTU02043 CBTL08GP053	Computing and server, USB Type-C, portable devices, wireless infrastructure	Best in class signal integrity in high speed USB, PCIe®, SATA, SAS, DisplayPort and Thunderbolt Smallest package for 2:1 mux (CBTU02043)	Networking and cloud computing (e.g., Cisco, Juniper, EMC)
Analog switches NX3DV42 NX3L1T3157 NX3L1T5157 NX3DV642	Fitness bands, consumer electronics, tablets, wireless speakers, embedded systems	Low RDS_{ON} , low quiescent current, wide portfolio of package types	Embedded system design
Application-specific switches CBTV24DD12 CBTW28DD14	Enterprise SSD and Memory Modules	Better signal integrity and lower cross talk Excellent quality control and long product lifecycle as reputable semi vendor	RAID and mass data storage controllers reference design

Solutions Around the Core

Signal Management

Voltage Level Translators

Your system may benefit from voltage-level translators if:

- ▶ You have multiple I/O voltage or voltage rails in your system
- ▶ You have a variety of different voltages to convert
- ▶ You need to isolate system peripherals or multiple loads on the bus

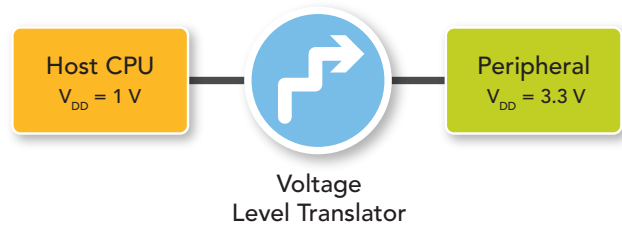

Type	Level Translation	Hero Parts	Key Application	Value Proposition
FET	Passive bidirectional with auto sensing	PCA9306 NVT2008	Server—Open drain (I ² C) with pull up or push pull 1–5 V signal	Very low standby current (5 mA), 1/2/3/6/8/10-bit widths
FET with one-shot	Passive bidirectional with auto sensing and one-shot	NTS0302 NTS0304E	Smartphone—Open drain (I ² C) with optional pull up or push pull 0.95–3.6 V signal	Smart one-shot for reduced ringing and better operation in 400 pF systems—“E” devices provide higher system-level ESD protection
GTL buffer	Active bidirectional with direction pin	GTL2014 GTL2034	Storage, servers and networking—GTL to LVTTTL	On Intel’s Grantley and Purley server ref designs
I ² C-bus buffer	Active bidirectional open drain with auto sensing	PCA9617A PCA9509	Server and networking—level translation and capacitance isolation—Open drain (I ² C) with pull up 0.8–5.5 V	On Intel®’s Grantley and Purley server ref designs—1 MHz
I ² C-bus mux/switch	Passive bidirectional with auto sensing	PCA9548A PCA9848	Server and Networking—Open drain (I ² C) with pull up 0.8–5.5 V for level translation and fault isolation	On Intel’s Grantley and Purley server ref designs—1 MHz
Bus keeper with one-shot	Active bidirectional with auto sensing and one-shot	NTB0102 NTB0104	Server and automotive—push pull 1.2 to 5.5 V	AEC-Q100 compliant and small package options
SIM card interface	Active bidirectional with auto sensing	NVT4555 NVT4556	Smartphone—SIM card interface level translator and supply voltage LDO	Automatic level translation of I/O, RSTn and CLKn between SIM card and host side
SDIO card interface	Active bidirectional with auto sensing	NVT4857	Smartphone—SD 3.0-SDR104 compliant integrated auto-direction control memory card voltage level translator	Supports SDR104, SDR50, DDR50, SDR25, SDR12 and SD 2.0 high-speed (50 MHz) and default-speed (25 MHz) modes
System power management interface	Passive bidirectional with auto sensing and one-shot	NVT0202	Smartphone—SPMI interface 52 Mbit/s between AP and peripheral components to support advanced power management techniques—0.7 to 1.98 V range	Low prop delay-small package option “JK”—works down to 0.7 V—use with open drain or push pull

Solutions Around the Core

System Management

Real-Time Clocks

If your system processor has an integrated real-time clock, do you:

- ▶ Need higher accuracy?
- ▶ Need a lower power external RTC?
- ▶ Need an external standalone RTC with battery management and alarm features?
- ▶ Need to support time-stamp/tamper detect functionality?

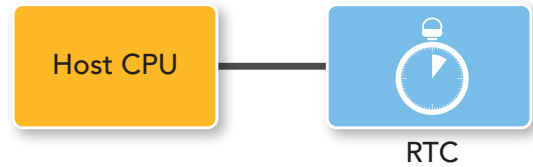

Functions	Interface	Hero Parts	Key Applications	Value Proposition
Low power	I ² C	PCF85063A, PCF85263A	Networking, server, consumer, POS	Industry's lowest power consumption, tiny package options with alarm feature
	SPI	PCF85063B, PCF2123		
High accuracy	I ² C and SPI	PCF2127(A), PCF2129(A)	Consumer	High accuracy ± 3 ppm with battery management, time stamp and internal crystal
Automotive	I ² C	PCA85073A, PCA8565, PCA2129	Battery management control, telematics	AEC-Q100 compliance, higher temperature operation
	SPI	PCA21125, PCA2129		
Latest Generation Full featured	I ² C	PCF85263A, PCF85363A	Industrial	Two alarms, watchdog, electronic tuning, battery management, time stamp and 64-byte RAM on 363A

GPIO Expanders

Your system may need GPIO expanders if:

- ▶ You've run out of I/O on your MCU
- ▶ You need to reduce the number of signal lines used for peripheral control
- ▶ You're limited by the drive capability of your MCU I/O

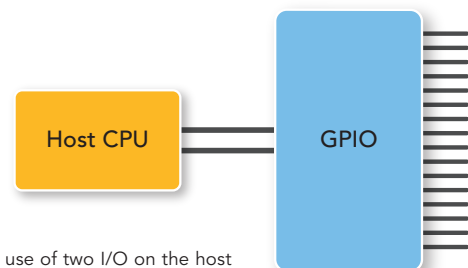

Allows use of two I/O on the host CPU to expand up to 4, 8, 16, 24, or 40 additional I/O

Bit-width	Hero Parts	Key Applications	Value Proposition
4-bit	PCA9570	IoT devices, wearable, handheld and portable devices	Tiny package, low power consumption
8-bit	PCAL6408A	Mobile, tablets, gaming, embedded computing	Ultra-low-power consumption and tiny packages with "Agile" I/O features: latchable inputs and programmable I/O features (drive strength, output structure, etc.)
16-bit	PCAL6416A		
16-bit	PCA9555A	Server, networking, wireless infrastructure	Low-power device and various package options; fully backward compatible to PCA9555, and operates from 1.65 to 5.50
24-bit	PCAL6524	Mobile, low-power applications	Ultra-low voltage support to 0.8 V, "Agile" I/O features
40-bit	PCA9698	Home and building automation, networking, computing/server/storage	Lots of flexibility with 40 bits available, 1 MHz I ² C-bus operation

Solutions Around the Core

HMI

LED Controllers

Your system may benefit from LED controllers if:

- ▶ You have a significant number of LEDs in your system that need controlling
- ▶ You need control over dimming/blinking/color mixing functions
- ▶ You need backlighting in your application
- ▶ Your application requires "breathing" functionality

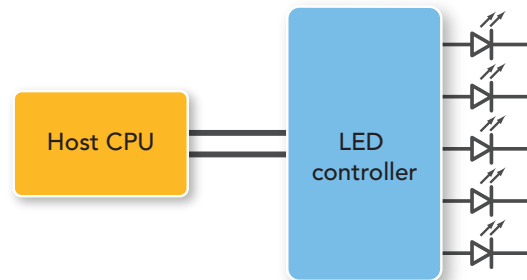

Control Type	Hero Parts	Key Applications	Value Proposition
Voltage source	PCA9632, PCA9633	Consumer devices, portable applications	4-bit devices with integrated PWMs to do color mixing/dimming; low-power version available (PCA9632), up to 25 mA 5 V
Voltage source	PCA9624, PCA9685	Gaming, home automation, industrial	Large number of channels allows control of multiple LEDs saving GPIO pins on MCU, up to 100 mA, 40 V
Constant current (I ² C)	PCA9955B, PCA9956B	Backlighting application, automotive, applications that require "breathing" support	Constant current support allows precise control of current through LEDs, thermally enhanced package, 1-MHz I ² C interface with software features for easy control, up to 57 mA, 20 V
Constant current (SPI)	PCA9745B	Backlighting, automotive, applications that require "breathing" support	Constant current support allows precise control of current through LEDs, thermally enhanced package, daisy chainable SPI interface with software features for easy control, up to 57 mA, 20 V

LCD Drivers

Your system may benefit from LCD drivers if:

- ▶ Your system has a passive monochrome display
- ▶ You want to save I/Os on the MCU while driving the display
- ▶ You need to display a high contrast level
- ▶ You need an external segment or character driver



Hero Parts	Key Applications	Value Proposition
PCA8561	Automotive and industrial; small displays with driver mounted on the back.	Small number of segment counts, small package size, programmable frame frequency, automotive qualified, low power consumption
PCF8551/PCA8551, PCF8553/PCA8553	E-metering, automotive, white goods	Automotive qualified, low power consumption
PCA8538, PCA8539	Automotive, Industrial	Chip-on-glass, automotive qualified, high and programmable frame frequency, high V _{LCD} with integrated charge pump, internal temperature sensor
PCA2117	Automotive Industrial (Character Drivers)	Chip-on-glass, automotive qualified

Solutions Around the Core Interfaces

I²C MUX and Switches

Your system may benefit from I²C MUX and switches if:

- ▶ You have issues with I²C slaves having the same address
- ▶ You have many slaves on the I²C bus and need to split the bus to simplify architecture
- ▶ You need debug capability and multi-master support in your system
- ▶ You need voltage-level translation

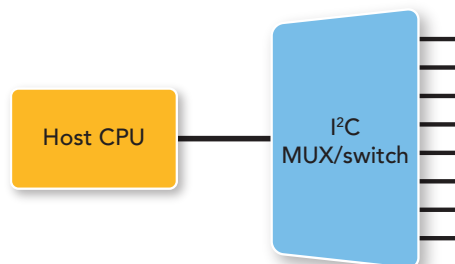





Function	Hero Parts	Key Applications	Value Proposition
Multiplexer	PCA9543A, PCA9547, PCA9847	Servers, networking, telecom, wireless infrastructure	Low-voltage device with address configurability PCA984x down to 0.8 V and up to 1 MHz
Switches	PCA9546A, PCA9548A, PCA9846, PCA9848	Servers, networking, telecom, wireless infrastructure	Low-voltage device with address configurability, level translation capability built in PCA984x down to 0.8 V and up to 1 MHz
Demux/Arbiter	PCA9541A, PCA9641	Servers, networking, telecom, wireless infrastructure	Multi-master system support with hardware arbitration capability PCA9641 has master arbitration and up to 1 MHz

Solutions Around the Core

NFC - A Different Kind of Wireless

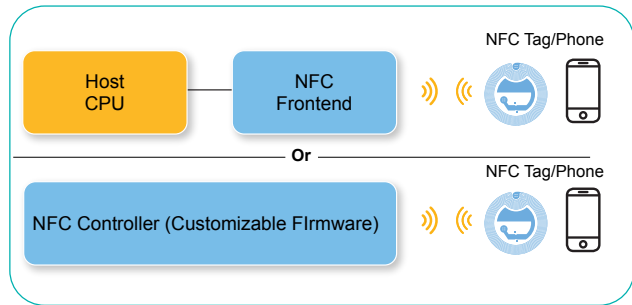

Access Control (Physical and Logical)

-  Use your phone to open doors at home, at work, or when you travel
-  Turn your wristband into a special-access pass
-  Grant temporary access to service personnel
-  Help increase productivity with fast access to specialized machinery



<p>NFC Frontend CLRC663 <i>plus</i></p>	<ul style="list-style-type: none"> If you already have a microcontroller on board, and need advanced NFC performance with the low power consumption, especially in a battery-operated system, use this NFC frontend to push your design further.
<p>NFC Controller with Customizable Firmware PN7462 PN736x</p>	<ul style="list-style-type: none"> If you need a small footprint, e.g., for a door lock, use these all-in-one solutions to execute a fully custom application. No external MCU needed.
<p>Contactless Multi-application Smart Card MIFARE® DESFire® EV2 MIFARE DESFire Light</p> 	<ul style="list-style-type: none"> If you're designing a card-based access system, get the benefit of CC EAL5+ security – the same certification level bank cards and electronic passports use. This NFC-compatible MIFARE solution is also available in multiple form factors from key fobs to wristbands.

Pairing and Commissioning

-  Pair with Bluetooth® devices faster
-  View images and videos on the big screen
-  Add nodes to your home or industrial network without entering codes

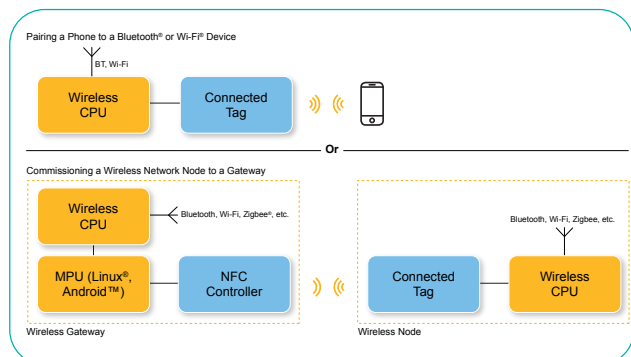





<p>NFC Connected Tag NTAG® I2C <i>plus</i>, NTAG 5 <i>boost</i></p>	<ul style="list-style-type: none"> If you're working on a battery-powered design that already has a microcontroller, such as a speaker or IoT node, use this tag IC to wake the system and initiate Bluetooth or Wi-Fi pairing. NTAG 5 boost gives good read range even with tiny antennas around x 10 mm.
<p>NFC Controller with Integrated Firmware PN71xx</p>	<ul style="list-style-type: none"> If you're running an OS such as Android, Windows, or Linux, use the embedded NFC firmware and NCI interface in these controllers to add fully compliant NFC functionality. The PN71xx is also a good choice for routers that will interact with NTAG-equipped nodes.

Solutions Around the Core

NFC - A Different Kind of Wireless



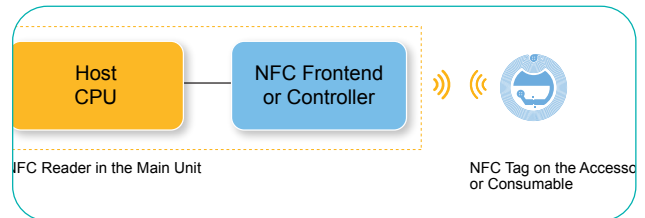

Accessories and Consumables

-  Combat counterfeits by authenticating accessories and attachments
-  Ensure safety with branded replacements that automatically adjust settings
-  Order branded replacements and consumables with a single tap, using authenticated redirection
-  Boost manufacturing by automatically choosing the right tool every time



NFC Frontend: MFRC630 NFC Tag ICs: NTAG21x, NTAG213 Tag Tamper, NTAG 413 DNA Tags: NTAG 21x, NTAG 213 TagTamper, NTAG 424 DNA TagTamper, NTAG 424 DNA	<ul style="list-style-type: none"> NFC tag ICs from the NTAG family offer a range of features and security options and can be read by all NFC phones. Once you've chosen a tag IC, the MFRC630 is an ideal single-protocol reader for this use case.
NFC Frontend SLRC610 NFC Tag ICs: ICODE [®] SLIX2, ICODE DNA	<ul style="list-style-type: none"> If you need to support longer distances between the tag and its reader, then the SLRC610 reader, which works with ICODE tags, gives you the extra margin in read range.
NFC Controller with Integrated Firmware PN71xx	<ul style="list-style-type: none"> If you're working with an OS such as Android, Windows, or Linux, use one of these controllers for plug-and-play functionality when reading NTAG, MIFARE[®], and ICODE tags.

Parameterization, Diagnosis and FW Update

-  Use an NFC phone as an external user interface to replace DIP switches
-  Enable full interactions with small, sealed devices that are not powered or don't have a battery at all
-  Read out data, access user manuals, or copy settings from one device to another
-  Use a phone to perform diagnostics or update the firmware, even if the device is unpowered

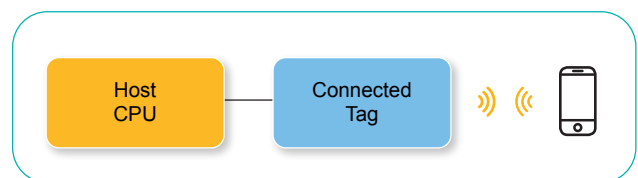





Connected Tag NTAG I2C plus	<ul style="list-style-type: none"> Adding this low-cost, small-footprint NFC interface makes your system compatible with any NFC phone or reader on the market.
Connected Tag NTAG 5 boost	<ul style="list-style-type: none"> For small devices, add this connected NFC tag to get extra read range even with tiny antennas around 10 x 10 mm.

Solutions Around the Core

NFC - A Different Kind of Wireless

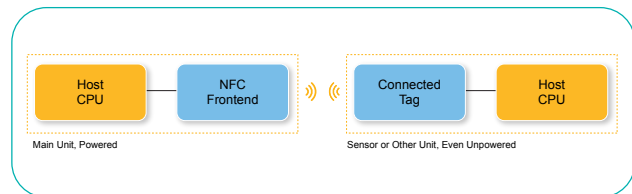

Device-to-Device and In-Device Communication

-  Avoid galvanic connections by letting machines talk without wires
-  Let a fully sealed, battery-free sensor unit interact with the meter housing
-  Record mechanical-stress readings on moving parts
-  NFC allows communication with up to 40 kbit/s and provides up to 30 mW via energy harvesting



NFC Frontend MFRC630 (for use with NTAG I ² C plus) SLRC610 (for use with NTAG 5)	<ul style="list-style-type: none"> If your system will be actively communicating with other devices or reading data from tags, use this high-performance yet cost-effective frontend to enable interaction.
Connected Tag NTAG I ² C plus	<ul style="list-style-type: none"> With this high-performance, energy-harvesting connected tag on board, your device can be read, measured, or made interactive—even if it doesn't have a power source.
Connected Tag NTAG 5 Link	<ul style="list-style-type: none"> With this connected NFC tag, you can harvest up to 30 mW of regulated power and connect any I²C slaves directly without any MCU.

Payment

-  Offer new kinds of loyalty and couponing programs
-  Let micro-merchants accept and confirm payments
-  Create self-service kiosks or vending machines
-  Get access to any kind of energy through prepaid systems
-  Use a secure, protected connection to access your bank or initiate transactions

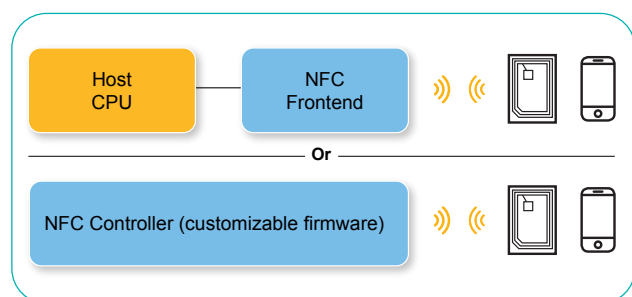

NFC Frontend PN5180, CLRC663 plus	<ul style="list-style-type: none"> If you want to enable NFC-based payments, and you already have a microcontroller on board, use one of these EMVCo-compliant frontends.
NFC Controller with Customizable Firmware PN7462	<ul style="list-style-type: none"> If you need a small footprint, use this single-chip solution to create a very compact design. You can easily add a coprocessor for time-critical functions in the EMVL1 protocol layer, for fast payment performance.
Contact reader front end TDA8035 TDA8026	<ul style="list-style-type: none"> If you want to support contact cards in your terminal, you can choose the single-slot TDA8035, or select the TDA8026 for use with multiple SAMs. Both offer full support for all classes of smartcard.

www.nxp.com

NXP, the NXP logo, MIFARE, the MIFARE logo, NTAG and ICODE are trademarks of NXP B.V. All other product or service names are the property of their respective owners. The Bluetooth® word mark and logos are registered trademarks owned by Bluetooth SIG, Inc. and any use of such marks by NXP Semiconductors is under license. Android and any related marks are trademarks of Google Inc. © 2018–2020 NXP B.V.

Document Number: A1UPFSA4 REV 2

